

Makita

アメリカ

Cordless Hedge Trimmer

300 mm (11-3/4'') MODEL UH3000D
300 mm (11-3/4'') MODEL UH3000DW
With Fast Charger

INSTRUCTION MANUAL

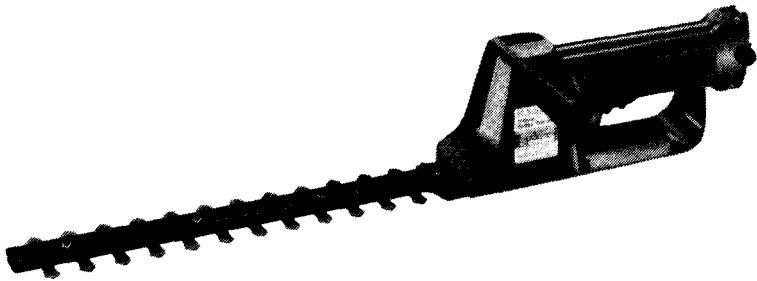

SPECIFICATIONS

• Model UH3000D			
Effective cutting blade length	Strokes per min.	Dimensions (L x W x H)	Net weight
300 mm (11-3/4'')	950	605 mm x 72 mm x 110 mm (23-7/8'' x 2-7/8'' x 4-3/8'')	1.6 kg (3.5 lbs)
• Battery Cartridge 7000		• Model DC7100 Fast Charger	
Voltage	Input	Output	Charging time
7.2 V	A.C. only 50 Hz — 60 Hz	D.C. 7.2 V	1 Hr.

- * Manufacturer reserves the right to change specifications without notice.
- * Note: Specifications may differ from country to country.

IMPORTANT SAFETY INSTRUCTIONS

(For All Tools)

WARNING: WHEN USING ELECTRIC TOOLS, BASIC SAFETY PRECAUTIONS SHOULD ALWAYS BE FOLLOWED TO REDUCE THE RISK OF FIRE, ELECTRIC SHOCK, AND PERSONAL INJURY, INCLUDING THE FOLLOWING:

READ ALL INSTRUCTIONS.

1. Be aware that this tool is always in an operating condition, because it does not have to be plugged into an electrical outlet.
2. **DRESS PROPERLY** — Do not wear loose clothing or jewelry. They can be caught in moving parts. Use of sturdy gloves, nonskid footwear and safety glasses is recommended.
3. **STAY ALERT** — Watch what you are doing — use common sense. Do not operate trimmer when fatigued.
4. **DANGER — RISK OF CUT — KEEP HANDS AWAY FROM BLADES** — Keep both hands on handles when power is on. Do not attempt to remove cut material nor hold material to be cut when blades are moving. Make sure trimmer switch is off when clearing jammed material from blades. Do not grasp the exposed cutting blades or cutting edges of trimmer. **CAUTION** — Blades coast after turn off.
5. **WARNING** — Don't use trimmer in rain, in wet locations, or on wet hedges of shrubbery.
6. **KEEP CHILDREN AWAY** — Do not permit children to use or touch trimmer. Keep children a safe distance from work area.
7. **USE TRIMMER PROPERLY** — Use only for trimming the type of shrub, growth, and the like, described in the operating instructions. Do not abuse trimmer.
8. **DON'T OVERREACH OR STAND ON UNSTABLE SUPPORT** — Keep good footing and balance at all times.
9. **AVOID UNINTENTIONAL STARTING OF TRIMMER** — Don't carry trimmer with finger on switch.
10. **AVOID LOCKING TRIMMER SWITCH ON** — Never attempt to tape, wire or fasten the switches so as to stay in the ON position.
11. **MAINTAIN TRIMMER WITH CARE** — Follow maintenance instructions given in manual.
12. **STORE TRIMMER INDOORS** — When not in use store trimmer indoors in a dry place where not accessible to children.

13. **DO NOT ATTEMPT TO REPAIR TRIMMER** — Have repairs made by qualified dealer or repairman. See that only identical replacement parts are used.
14. Hold the tool firmly with both hands.
15. It is extremely dangerous to grasp branches while cutting. If the blades jam, because of a piece of wire or impacted branch, switch off immediately and remove the material stuck in the blades.
16. Do not use hedge trimmer to cut grass or weeds.
17. When not in use, be sure to cover the blades with the blade guard.

IMPORTANT SAFETY INSTRUCTIONS

1. **SAVE THESE INSTRUCTIONS** — This manual contains important safety and operating instructions for battery charger.
2. Before using battery charger, read all instructions and cautionary markings on (1) battery charger, (2) battery, and (3) product using battery.
3. **CAUTION** — To reduce risk of injury, charge only MAKITA Battery 7000. Other types of batteries may burst causing personal injury and damage.
4. Do not expose charger to rain or snow.
5. Use of an attachment not recommended or sold by the battery charger manufacturer may result in a risk of fire, electric shock, or injury to persons.
6. To reduce risk of damage to electric plug and cord, pull by plug rather than cord when disconnecting charger.
7. Make sure cord is located so that it will not be stepped on, tripped over, or otherwise subjected to damage or stress.
8. An extension cord should not be used unless absolutely necessary. Use of improper extension cord could result in a risk of fire and electric shock. If extension cord must be used, make sure:
 - a. That pins on plug of extension cord are the same number, size, and shape as those of plug on charger;
 - b. That extension cord is properly wired and in good electrical condition; and
 - c. That wire size is at least as large as the one specified in the table below.

**TABLE 1
RECOMMENDED MINIMUM AWG SIZE FOR
EXTENSION CORDS FOR BATTERY CHARGERS**

Length of Cord (Feet)	25	50	100	150
AWG Size of Cord	18	18	18	16

9. Do not operate charger with damaged cord or plug — replace them immediately.
10. Do not operate charger if it has received a sharp blow, been dropped, or otherwise damaged in any way; take it to a qualified serviceman.
11. Do not disassemble charger or battery cartridge; take it to a qualified serviceman when service or repair is required. Incorrect reassembly may result in a risk of electric shock or fire.
12. To reduce risk of electric shock, unplug charger from outlet before attempting any maintenance or cleaning. Turning off controls will not reduce this risk.

ADDITIONAL SAFETY RULES FOR CHARGER & BATTERY CARTRIDGE

1. Do not charge Battery Cartridge when temperature is BELOW 10°C (50°F) or ABOVE 40°C (104°F).
2. Do not attempt to use a step-up transformer, an engine generator or DC power receptacle.
3. Do not allow anything to cover or clog the charger vents.
4. Always cover the battery terminals with the battery cover when the battery cartridge is not used.
5. A battery short can cause a large current flow, overheating, possible burns and even a breakdown.
 - (1) Do not touch the terminals with any conductive material.
 - (2) Avoid storing battery cartridge in a container with other metal objects such as nails, coins, etc.
 - (3) Do not expose battery cartridge to water or rain.
6. Do not store the tool and Battery Cartridge in locations where the temperature may reach or exceed 50°C (122°F).
7. Do not incinerate the Battery Cartridge even if it is severely damaged or is completely worn out. The battery cartridge can explode in a fire.

SAVE THESE INSTRUCTIONS.

Installing or removing battery cartridge

- Always switch off the tool before insertion or removal of the battery cartridge.
- To remove the battery cartridge, pull out the set plate on the bottom of the tool and grasp both sides of the cartridge while withdrawing it from the barrel.
- To insert the battery cartridge, align the tongue on the battery cartridge with the groove in the housing and slip it into place. Snap the set plate back into place. Be sure to close the set plate fully before using the tool.

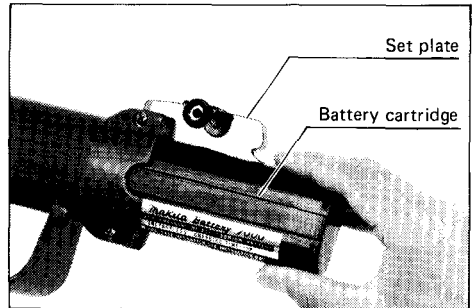

- Do not use force when inserting the battery cartridge. If the cartridge does not slide in easily, it is not being inserted correctly.

Charging

Plug the fast charger into your power source. Insert the battery cartridge so that the plus and minus terminals on the battery cartridge are on the same sides as their respective markings on the fast charger. Insert the cartridge fully into the port so that it rests on the charger port floor.

The charging light will come on and charging will begin. If the charging light does not come on, press the reset button. If the charging light goes out within 10 seconds even after pressing the reset button a couple of times, the battery cartridge is dead. (CAUTION: Wait for more than 5 seconds after the charging light goes out to press the reset button again.) Replace it with a new one. When the charging light goes out after about one hour, you may remove the fully charged battery cartridge. After charging, unplug the charger from the power source.

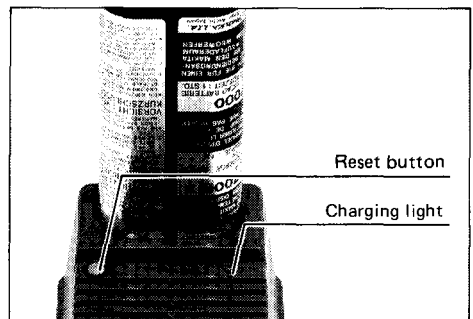

The charging light will come on and charging will begin. If the charging light does not come on, press the reset button. If the charging light goes out within 10 seconds even after pressing the reset button a couple of times, the battery cartridge is dead. (CAUTION: Wait for more than 5 seconds after the charging light goes out to press the reset button again.) Replace it with a new one. When the charging light goes out after about one hour, you may remove the fully charged battery cartridge. After charging, unplug the charger from the power source.

CAUTION:

- Your new battery cartridge is not charged. You will need to charge it before use.
- If you try to charge a cartridge from a just-operated tool, sometimes the charging light will not come on. If this occurs, let the cartridge cool off for a while. Then re-insert it and try to charge it once more.
- When you charge a new battery cartridge or a battery cartridge which has not been used for a long period, it may not accept a full charge. This is a normal condition and does not indicate a problem. You can recharge the battery cartridge fully after discharging it completely a couple of times.
- If you wish to charge two battery cartridges, allow 15 minutes between chargings on the fast charger.

Side grip

Install the side grip (standard equipment) securely.

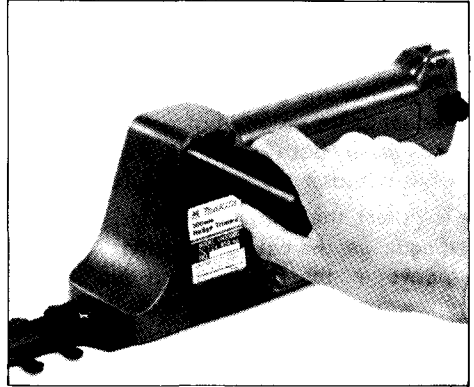

Switch operation

The switch has a special lock-off lever to prevent accidental operation or tampering. When the lever is pressed in the arrow direction (see photo at right), the trigger can be pulled to put the trimmer ON; simply release the trigger to switch OFF. The lock-off lever automatically returns to keep the trimmer OFF.

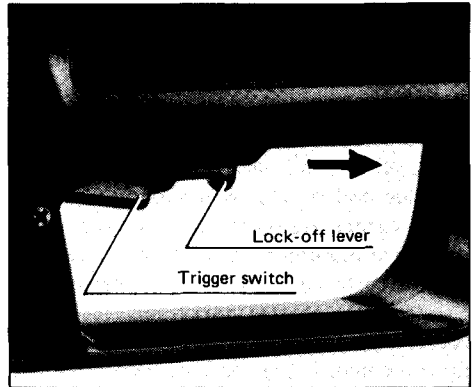

CAUTION:

Before inserting the battery cartridge, check to be sure that the released trigger switch has come out (spring return).

For better trimming

- 1) Branches and foliage of over 8 mm (5/16") should first be cut with shears down to the hedge trimming level.



2) Grip the trimmer with both hands and move it in front of your body.

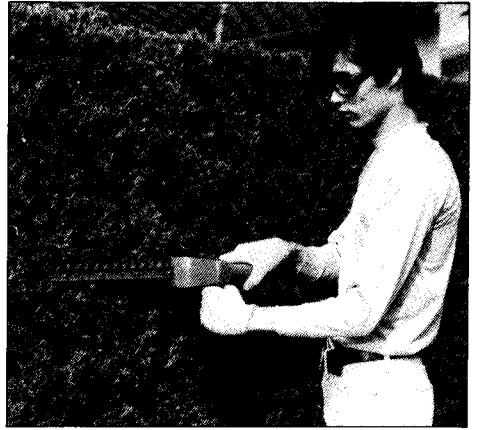

3) To cut a hedge top evenly, it helps to tie a string or cord at the desired hedge height and to trim along it.



4) To cut a hedge side evenly, it helps to cut from the bottom upwards.

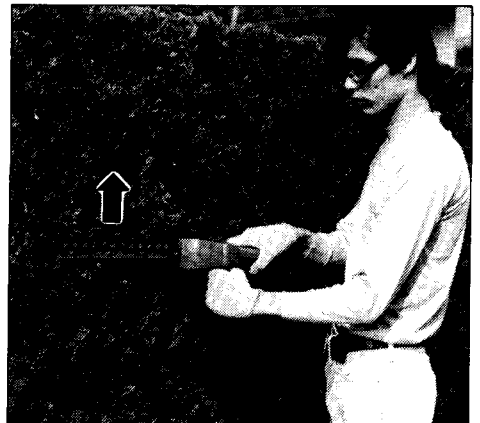

- 5) Trim boxwood or rhododendron from the base toward the top for a nice appearance and good job.

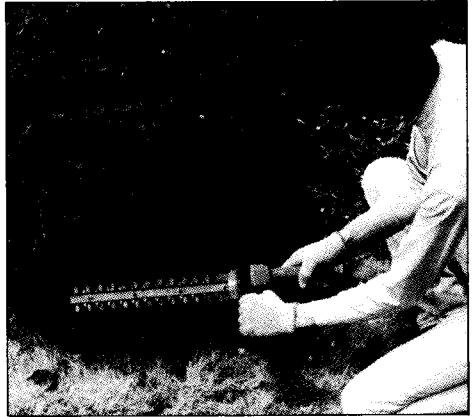

CAUTION :

1. Be careful not to accidentally contact a metal fence or other hard objects while trimming. The blade will break and may cause serious injury.
2. Do not leave the tool in rain, or in wet location.

NOTE :

You can expect up to 40 minutes running time on a single charge.

MAINTENANCE

CAUTION:

Always be sure that the tool is switched off and the battery cartridge is removed before attempting to perform inspection or maintenance.

After cutting is finished, clean off cutters (both sides) with a wire brush. Wipe off with a cloth and apply machine oil of low viscosity.

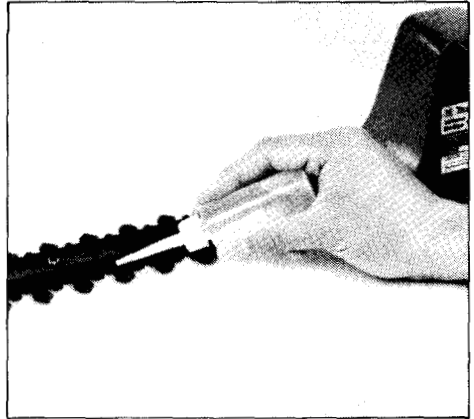
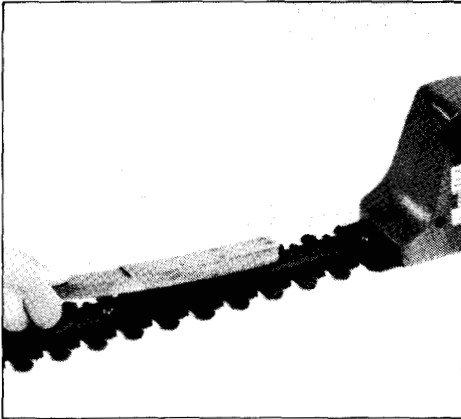

CAUTION:

Dirt and corrosion cause blade friction which in turn means less cutting time per battery charge. Keep the cutter blades clean and in good condition.

When storing, cover cutter blades with the sheath (blade guard) and store in a dry place out of the reach of children.

To maintain product SAFETY and RELIABILITY, repairs, maintenance or adjustment should be performed by Makita Authorized or Factory Service Centers, always using Makita replacement parts.

ACCESSORIES

CAUTION:

These accessories or attachments are recommended for use with your Makita tool specified in this manual. The use of any other accessories or attachments might present a risk of injury to persons. The accessories or attachments should be used only in the proper and intended manner.

- **Fast charger**

Model DC7100



- **Charger 12V for car**

Model DC7112



- **Battery cartridge 7000**

Part No. 632003-2

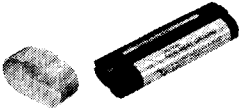

- **Shear blade assembly**

Part No. STEX 122285



- **Grip 34**

Part No. 273499-4



- **Blade cover**

Part No. 410471-7

- **Battery holster**

Holster holds extra battery.

Part No. 823033-3C

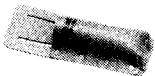

300 mm (11-3/4") CORDLESS HEDGE TRIMMER Model UH3000D

Type 1

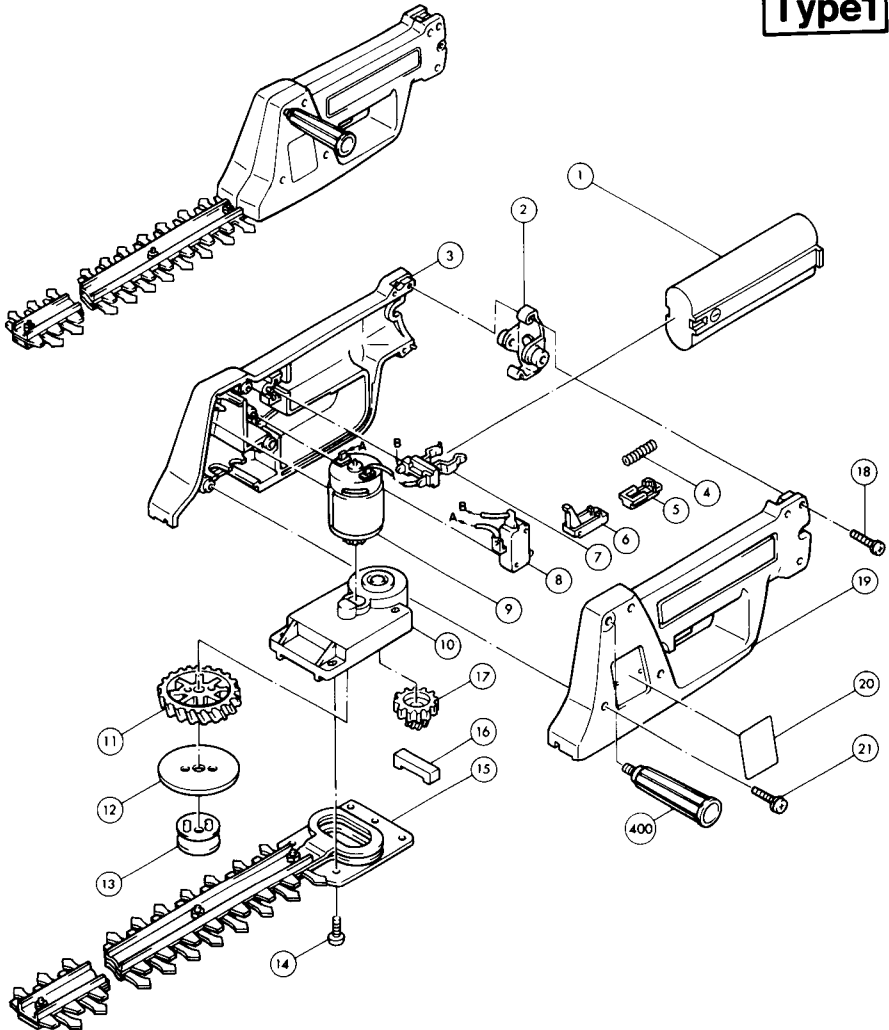

Note: The switch and other part configurations may differ from country to country.

ITEM NO.	NO. USED	DESCRIPTION	ITEM NO.	NO. USED	DESCRIPTION
MACHINE			MACHINE		
1	1	Battery 7000	12	1	Plate
2	1	Set Plate	13	1	Crank
3	1	Housing Set (With Item 19)	14	1	Pan Head Screw M4x15
4	1	Compression Spring 3	15	1	SHEAR BLADE ASSEMBLY
5	1	Lock-Off Lever	16	1	Sponge Seal
6	1	Switch Lever	17	1	Gear 14-34
7	1	Battery Holder	18	3	Pan Head Screw M4x22 (With Washer)
8	1	Switch	19	1	Housing Set (With Item 3)
9	1	Motor (D.C. 7.2 V.)	20	1	Name Plate
10	1	Gear Housing	21	2	Pan Head Screw M4x50 (With Washer)
11	1	Helical Gear 52	400	1	Grip 34

Note: The switch and other part specifications may differ from country to country.

Recycling the Battery

The only way to dispose of a Makita battery is to recycle it. The law prohibits any other method of disposal.

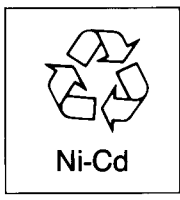

To recycle the battery:

1. Remove the battery from the tool.
 2. a). Take the battery to your nearest Makita Factory Service Center
or
b). Take the battery to your nearest Makita Authorized Service Center or Distributor that has been designated as a Makita battery recycling location.
- *Call your nearest Makita Service Center or Distributor to determine the location that provides Makita battery recycling. See your local Yellow Pages under "Tools-Electric".*

MAKITA LIMITED ONE YEAR WARRANTY

Warranty Policy

Every Makita tool is thoroughly inspected and tested before leaving the factory. It is warranted to be free of defects from workmanship and materials for the period of ONE YEAR from the date of original purchase. Should any trouble develop during this one-year period, return the COMPLETE tool, freight prepaid, to one of Makita's Factory or Authorized Service Centers. If inspection shows the trouble is caused by defective workmanship or material, Makita will repair (or at our option, replace) without charge.

This Warranty does not apply where:

- repairs have been made or attempted by others;
- repairs are required because of normal wear and tear;
- The tool has been abused, misused or improperly maintained;
- alterations have been made to the tool.

IN NO EVENT SHALL MAKITA BE LIABLE FOR ANY INDIRECT, INCIDENTAL OR CONSEQUENTIAL DAMAGES FROM THE SALE OR USE OF THE PRODUCT. THIS DISCLAIMER APPLIES BOTH DURING AND AFTER THE TERM OF THIS WARRANTY.

MAKITA DISCLAIMS LIABILITY FOR ANY IMPLIED WARRANTIES, INCLUDING IMPLIED WARRANTIES OF "MERCHANTABILITY" AND "FITNESS FOR A SPECIFIC PURPOSE," AFTER THE ONE-YEAR TERM OF THIS WARRANTY.

This Warranty gives you specific legal rights, and you may also have other rights which vary from state to state. Some states do not allow the exclusion or limitation of incidental or consequential damages, so the above limitation or exclusion may not apply to you. Some states do not allow limitation on how long an implied warranty lasts, so the above limitation may not apply to you.

Makita Corporation
3-11-8, Sumiyoshi-cho,
Anjo, Aichi 446 Japan

883558C064

PRINTED IN JAPAN
1994 — 10 — N